

MODEL: GR-130EX

SPECIFICATIONS

MAXIMUM CAPACITY PERFORMANCE	13,000 kg at 1.5 m
Max. traveling speed	49 km/h
Gradeability (tan θ)	53% (at stall), 30%*
* Machine should be operated within limit of engine crackcase design. (30°: Mitsubishi 4M50-TLC1B/TLE3A)	
WEIGHT	
Gross vehicle mass	14,145 kg (incl. 1.8 ton hook block)
-front axle	7,100 kg
-rear axle	7,045 kg
MIN. TURNING RADIUS	6.5 m (2-wheel steering), 3.8 m (4-wheel steering) (at center of extreme outer tire)
BOOM	6-section full power partially synchronized telescoping boom.
Fully retracted length	5.3 m
Fully extended length	23.8 m
Extension speed	18.5 m in 52 s
Angle	-3°-82°
Elevation speed	-3° to 82° in 29 s
JIB	2-staged under slung boom with quadruple offset. Single sheave at jib head.
Offset	5°, 25°, 45°, 60°
Length	3.6 m and 5.5 m
MAIN WINCH	Variable speed type with grooved drum driven by hydraulic axial piston motor.
Single line pull	17.6 kN {1,800 kgf}
Single line speed	125 m/min. (at 5th layer)
Wire rope	11.2 mm x 137 m (Diameter x length)
AUXILIARY WINCH	Variable speed type with grooved drum driven by hydraulic axial piston motor.
Single line pull	17.6 kN {1,800 kgf}
Single line speed	110 m/min. (at 3rd layer)
Wire rope	11.2 mm x 70 m (Diameter x length)
SLEWING	
Slewing speed	2.4 min ⁻¹ {rpm}
Tail slewing radius	1,600 mm
HYDRAULIC SYSTEM	Pumps... 2 variable piston pumps for crane functions. Tandem gear pump for steering, slewing and optional equipment. Control valves... Multiple valves actuated by pilot pressure with integral pressure relief valves. Reservoir... 172 liters capacity. External sight level gauge. Oil cooler... Air cooled fan type.

TADANO Automatic Moment Limiter (TADANO AML-C)	Following information is displayed: <ul style="list-style-type: none"> Control lever lockout function with audible and visual pre-warning Number of parts of line Boom position indicator Outrigger state indicator Slewing angle Boom angle / boom length / jib offset angle / jib length / load radius / rated lifting capacities / actual loads read out Potential lifting height Ratio of actual load moment to rated load moment indication Permissible load Automatic speed reduction and slow stop function for boom elevation and slewing Working condition register switch Load radius / boom angle / tip height / slewing range preset function External warning lamp Tare function Main hydraulic oil pressure Fuel consumption monitor Drum rotation indicator (audible and visible type) main and auxiliary winch On-rubber indicator
OUTRIGGERS	4 hydraulic, beam and jack outriggers. Vertical jack cylinders equipped with integral holding valve. Each outrigger beam and jack is controlled independently from cab.
Extension width	Max. ... 4,700 mm, Mid. ... 4,300 mm, 3,500 mm, 2,500mm Min. ... 1,640 mm, Float size (Diameter)... 350 mm
CARRIER	Rear engine, right-hand drive, driving axle 2-way selected type by manual switch. 4 x 2 front drive, 4 x 4 front and rear drive.
ENGINE	Model... Mitsubishi 4M50-TLC1B 4M50-TLE3A Type... 4-cycle, turbo charged and after cooled, direct injection diesel. Piston displacement... 4.90 liters Bore x stroke... 114 mm x 120 mm Max. output... 129 kW at 2,700 min ⁻¹ {rpm} Max. torque... 529 N·m at 1,600 min ⁻¹ {rpm}
TRANSMISSION	Electronically controlled full automatic transmission.
STEERING	Hydraulic power steering controlled by steering wheel. 4 steering modes available: 2 wheel front, 2 wheel rear, 4 wheel coordinated and 4 wheel crab.
SUSPENSION	Front: Semi-elliptic leaf springs with hydraulic lockout device. Rear: Semi-elliptic leaf springs with hydraulic lockout device.
TIRES	275/80R22.5 (OR)
FUEL TANK CAPACITY	189 liters



Lifting your dreams

ROUGH TERRAIN CRANE

GR-130EX

13 METRIC TON CAPACITY

ROUGH TERRAIN CRANE

WORKING RANGE

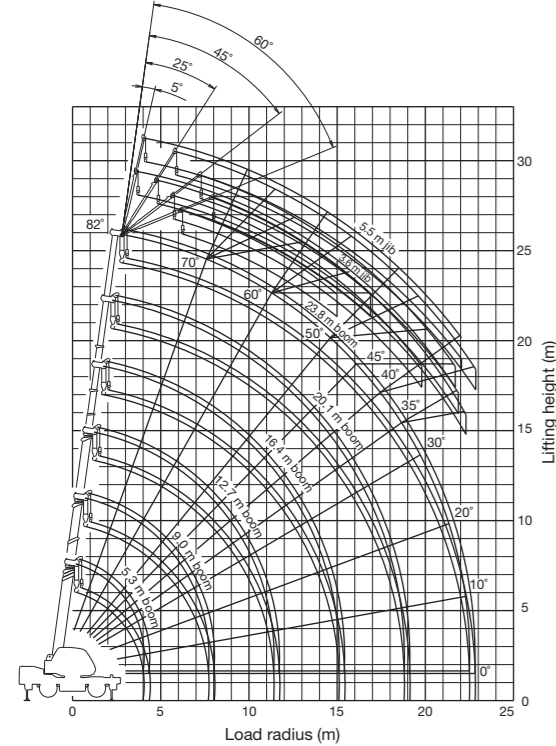

DIMENSIONS**

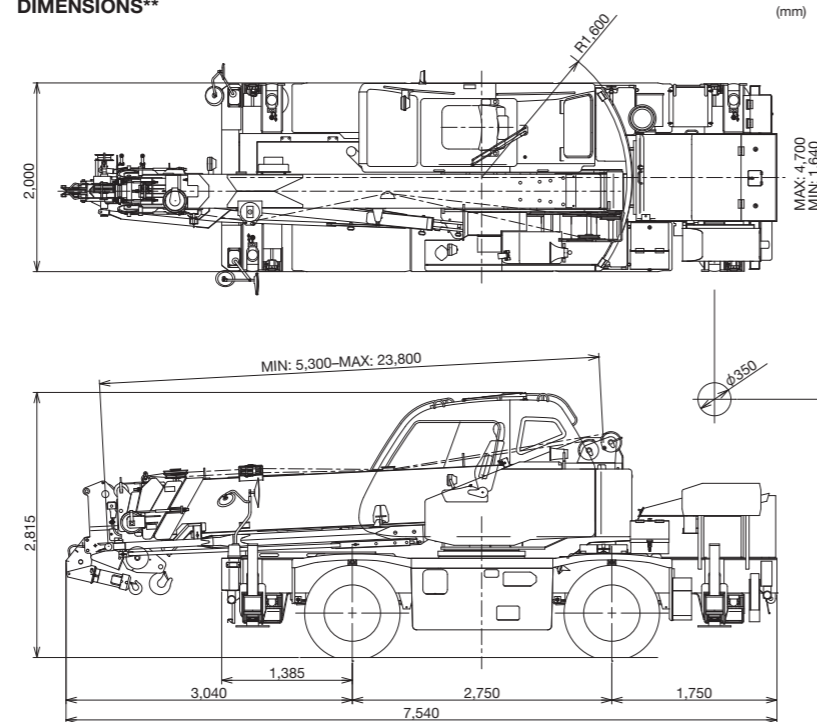

**In this external views, a few equipment are included.

NOTE: Some specifications are subject to change.



*The GR-130EX:
High Quality We Are Proud Of*



TADANO LTD. (International Sales Division)
4-12, Kamezawa 2-chome, Sumida-ku Tokyo 130-0014, Japan
Phone: +81-3-3621-7750 Fax: +81-3-3621-7785
http://www.tadano.com/ E-mail: info@tadano.com



Little Crane, Big Power.

An attractive feature of this crane is its small size. It also has high lifting capacity and the longest boom in its class.



ROUGH TERRAIN CRANE GR-130EX

Benefits of the GR-130EX

A compact and highly maneuverable design enables operators to complete jobs more efficiently compared to other bulkier alternative models.

- Easy approach to tight or busy job sites
- Quick Setup
- Asymmetrical outriggers offer maximum work value
- Reduced transportation costs

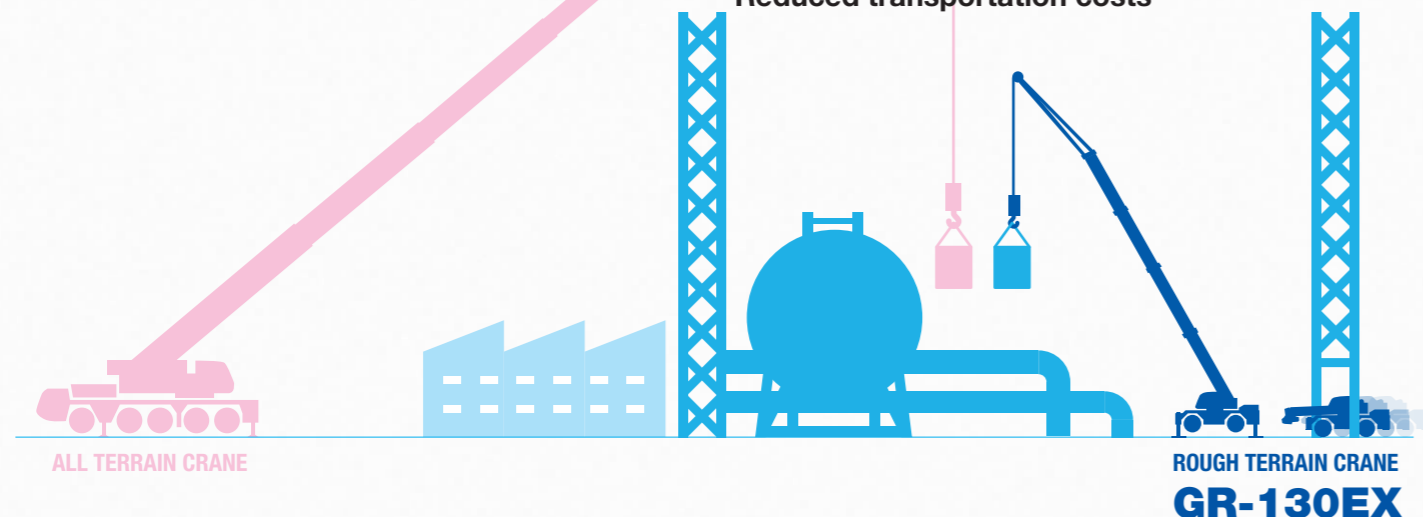

Carrier

Substantial safety devices allow excellent operability.

Unobstructed view when driving

Down-slanted boom improves front and side views. A front view monitor and camera also improve driver visibility.



Front view monitor



Front Camera

Suspension

Semi-elliptic leaf springs with hydraulic lockout device.

Fast Traveling Speed

Max. Traveling Speed: 49 km/h

High Performance Engine

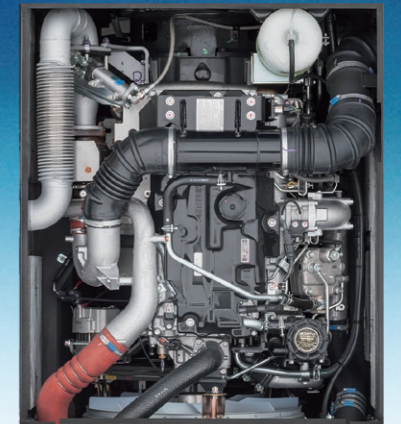

Mitsubishi 4M50-TL
4 cycle, turbo-charged and after cooled.
Max. Output: 129 kW at 2,700 min⁻¹ {rpm}
Max. Torque: 529 N·m at 1,600 min⁻¹ {rpm}

Hook Block Storage

Hook block stowing system enhances work efficiency.



Highly Maneuverability

The compact carrier can smoothly maneuver in narrow spaces.

Overall Length: approx. 7,540 mm

Overall Width: approx. 2,000 mm

Overall Height: approx. 2,815 mm

Min. Turning Radius: 3.8 m (4-wheel steering)

6.5 m (2-wheel steering)

* 275/80R22.5 Tires

New design head lamp

New Headlight Design.
Halogen headlights is equipped.



OPTIONAL EQUIPMENT

- Discharge head lamp
- Power stowing mirror
- Centralized lubricating system (Carrier portion)



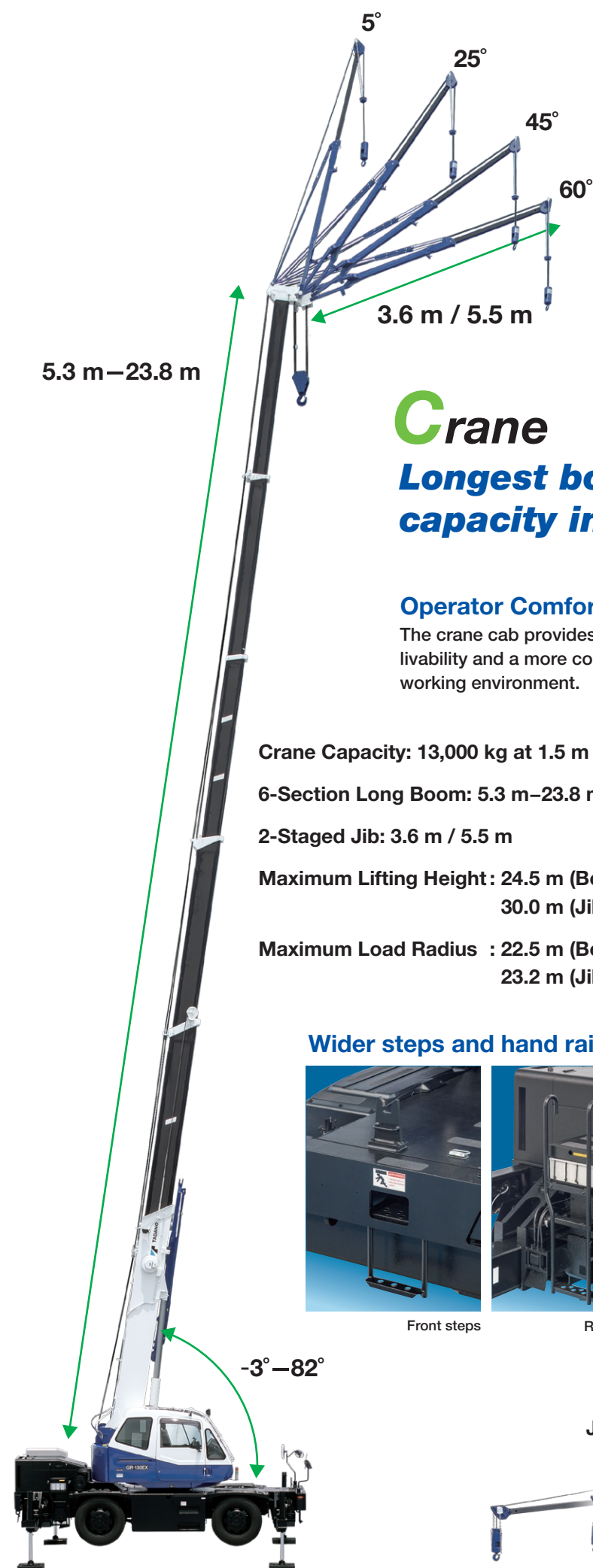

Crane

Longest boom & highest lifting capacity in its class!

Operator Comfort

The crane cab provides improved livability and a more comfortable working environment.



- Crane Capacity: 13,000 kg at 1.5 m
- 6-Section Long Boom: 5.3 m–23.8 m
- 2-Stage Jib: 3.6 m / 5.5 m
- Maximum Lifting Height: 24.5 m (Boom)
30.0 m (Jib)
- Maximum Load Radius : 22.5 m (Boom)
23.2 m (Jib)

Wider steps and hand rails



Front steps

Rear steps

Under-Slung Jib

A two-stage, under slung jib makes installation in narrow spaces possible.



Jib installation

HELLO-NET New

The HELLO-NET System is used to monitor crane activity straight from your computer or mobile device. You have the ability to view work history, machine position data and maintenance information. HELLO-NET provides advanced customer support between the owners' site and TADANO Group.

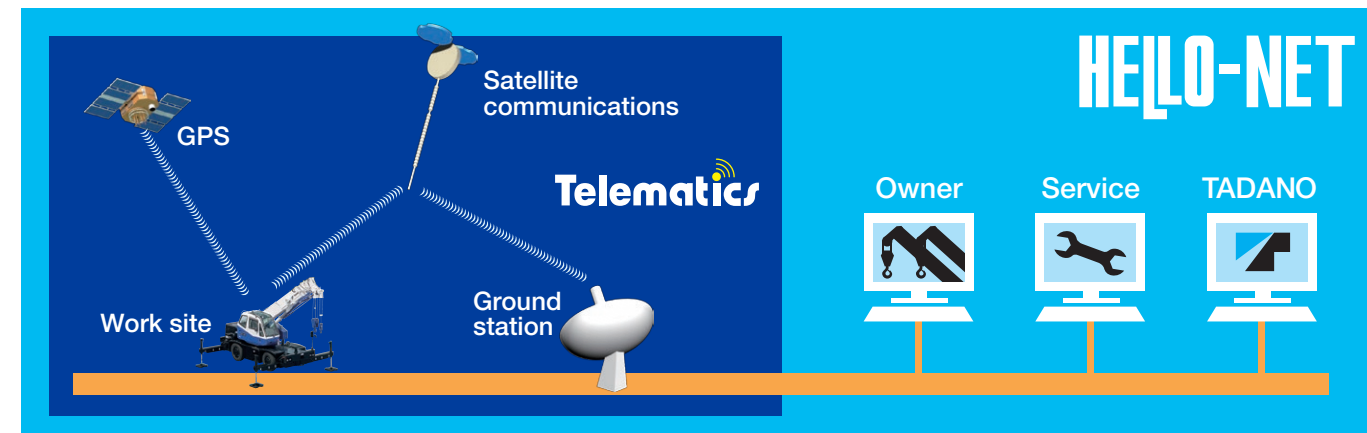

Note: HELLO-NET availability varies by situation. For detail, please contact your distributor or our sales staff in charge.

Environmentally Friendly Features

Eco Mode System

The system reduces fuel consumption and CO₂ emissions while the crane is in operation.



Eco mode switch

Fuel Monitoring System

The system constantly monitors fuel consumption on the AML screen.

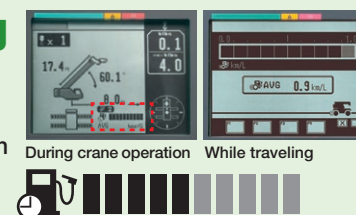

During crane operation While traveling

Automatic moment limiter [AML-C]



Tadano's AML-C is easy to use, innovative in design, displays important information to the operator and enables the operator to preset a custom working environment. For example, the AML-C shows the boom angle, boom length, load radius, operating pressure of the elevating cylinder, the extension width of the outriggers, slewing position, rated lifting capacity and present hook load. These features allow the AML-C to move seamlessly through all lifting operations without having to change configurations or input new codes to make the lift. The AML-C safety features provide both audible and visual warnings. When an operation approaches the load limit Tadano's slow stop function engages to avoid shock loads.



AML lamp

Outrigger Asymmetric Extension Width Control

When operating the crane with the asymmetric outriggers extended, the AML-C detects the extension width of all of the crane's outriggers (front, rear, left and right) to measure maximum work capacity in each area. When slewing the boom from the longer outrigger area to the shorter outrigger area, the AML-C detects the motion and displays the maximum capacity according to the extension width of each of the outriggers, and brings the motion to a slow stop before it reaches the maximum capacity. The AML-C's slow stop function will help to minimize any safety risks even in the cases of operator error.

